

## *iQ Series*

ULTRASONIC GENERATOR/POWER SUPPLY

## *Auto Plus*



HAND PROBE



AUTOMATED



PRESS

## Automation Interface Guidelines



## **Index**

P1 System Inputs/Outputs	3
Connecting System Inputs (PLC Sourcing Output Card)	4
Connecting a PLC Sinking Output Card	5
Connecting a Relay Contact Closure	6
Connecting System Outputs (PLC Sourcing Input Card)	7
Connecting a PLC Sinking Input Card	8
Connecting an Automation Safety Circuit	9
Remote Setup Switching	10
<b>iQ Auto Plus Timing Diagrams</b>	
iQ Auto Plus Weld-by-Automation	11
iQ Auto Plus Weld-by-Time	12
iQ Auto Plus With MPCQ Weld-by-Automation Timing	13

### P1 System Inputs/Outputs

Pin	Description
1	Enable Out (+22VDC Current Limited)
2	Enable In (Jumper to Pin 1, without E-Stop switch)
3	Overload Out
4	Ready Out
5	Any Fault Out
6	U/S Status Out
7	Output Common (Isolated)
8	Remote Setup 0 Input
9	Remote Setup 1 Input
10	Remote Setup 2 Input
11	Remote Setup 3 Input
12	Remote Common (Isolated)
13	U/S Activate
14	U/S Common (Isolated)

**Table 1**

**Note:** For detailed signal descriptions, please refer to the product manual.

## Connecting System Inputs

All System Inputs are optically isolated from the internal circuits and can be connected to sinking or sourcing PLC output cards. The inputs will draw approximately 10mA with a 24Vdc supply. The Systems Inputs can also be configured for a contact closure if necessary.

### PLC Sourcing Output Card

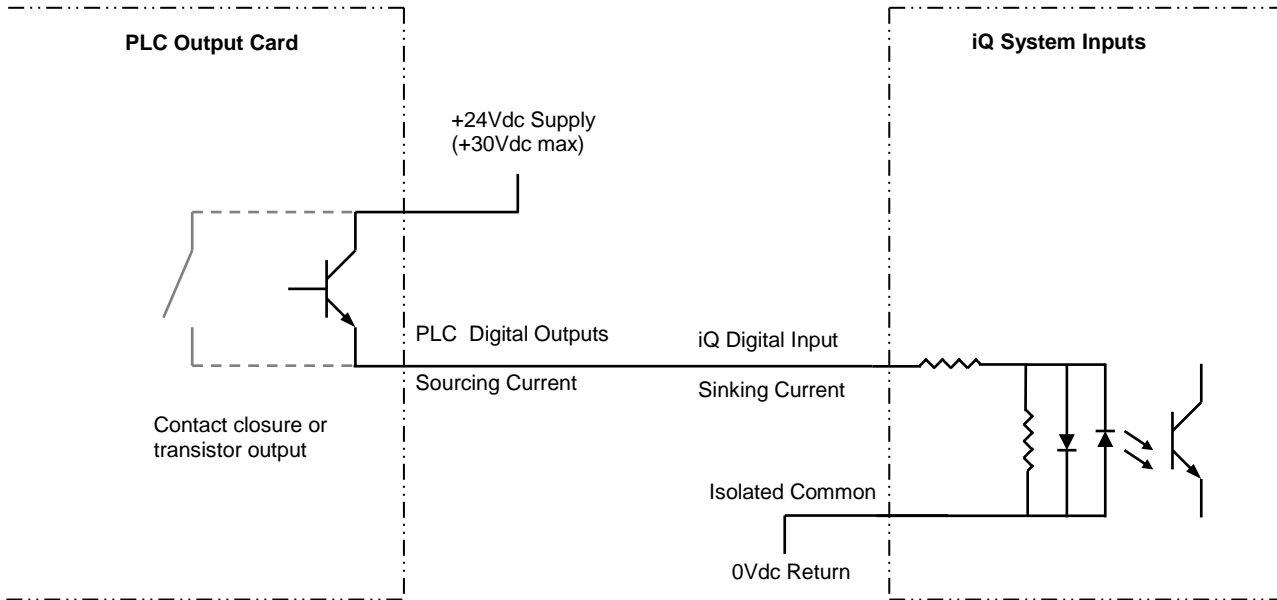

**Note:** Remote Setup Selection Inputs share the same Isolated Common (P1 pin 12). U/S Activate Input has a separate Isolated Common (P1 pin 14). See table 1. It is critical that the REMOTE and US Commons are connected to either positive supply or ground.

**Warning:** Any connection to the U/S Activate Input should be disabled during an emergency stop condition.

#### Connecting a PLC Sinking Output Card

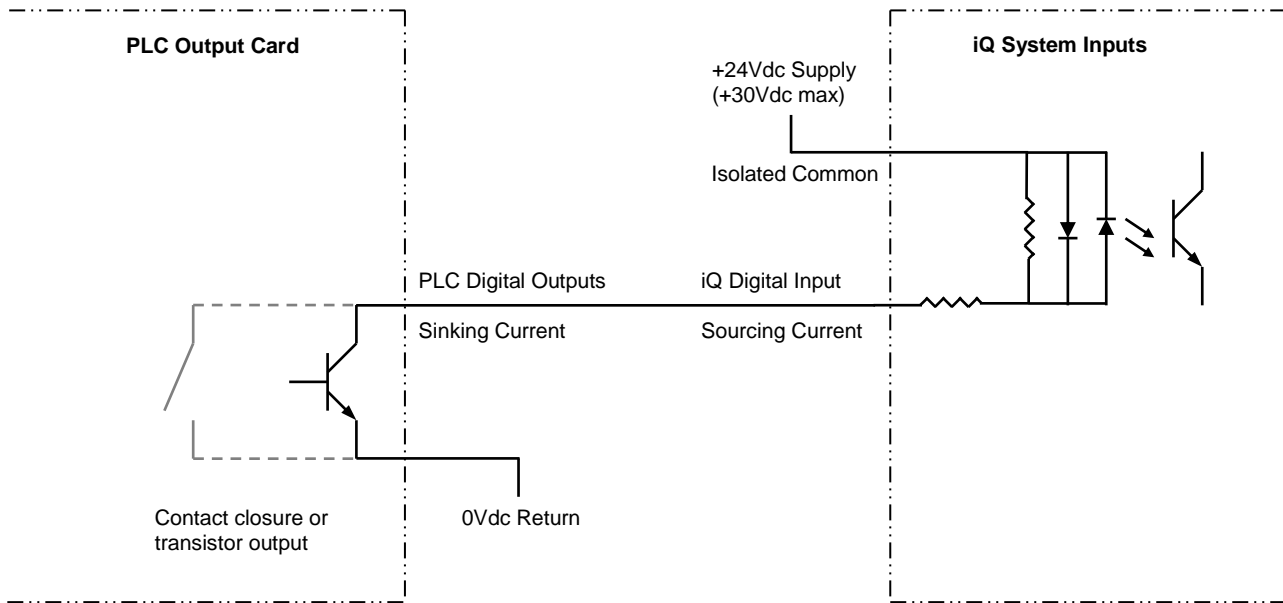

**Note:** Remote Setup Selection Inputs share the same Isolated Common (P1 pin 12). U/S Activate Input has a separate Isolated common (P1 pin 14). See table 1. It is critical that the REMOTE and US Commons are connected to either positive supply or ground.

**Warning:** Any connection to the U/S Activate Input should be disabled during an emergency stop condition. It is critical that the REMOTE and US Commons are connected to either positive supply or ground.

#### Connecting a Relay Contact Closure

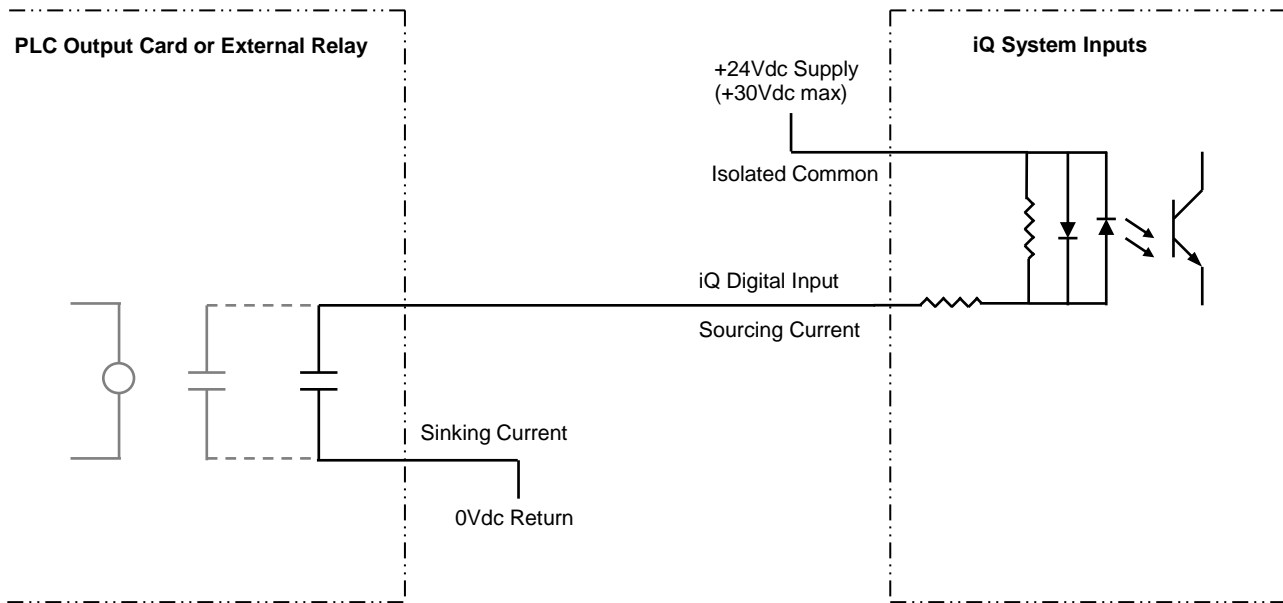

**Note:** Remote Setup Selection Inputs share the same Isolated Common (P1 pin 12). U/S Activate Input has a separate common (P1 pin 14). See table 1. It is critical that the REMOTE and US Commons are connected to either positive supply or ground.

**Warning:** Any connection to the U/S Activate Input should be disabled during an emergency stop condition.

## Connecting System Outputs

All System Outputs are optically isolated from the internal circuits. These outputs can be connected sinking or sourcing PLC input card.

### PLC Sourcing Input Card

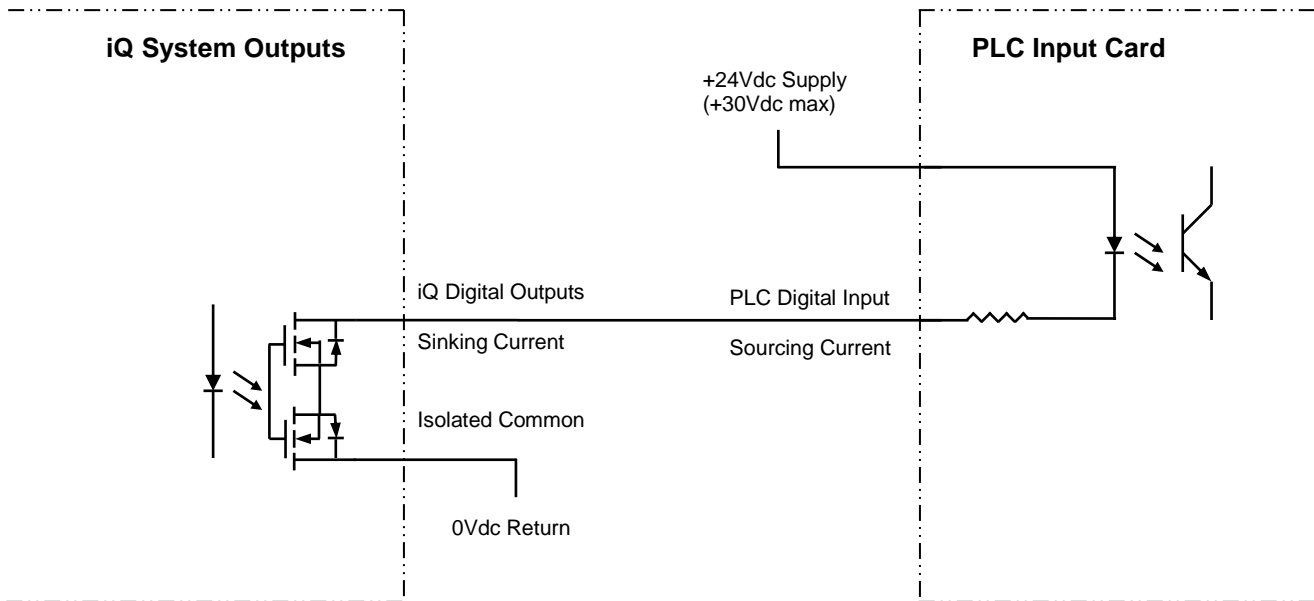

**Note:** All System Outputs share the same Isolated Common (P1 pin 7).

## Connecting a PLC Sinking Input Card

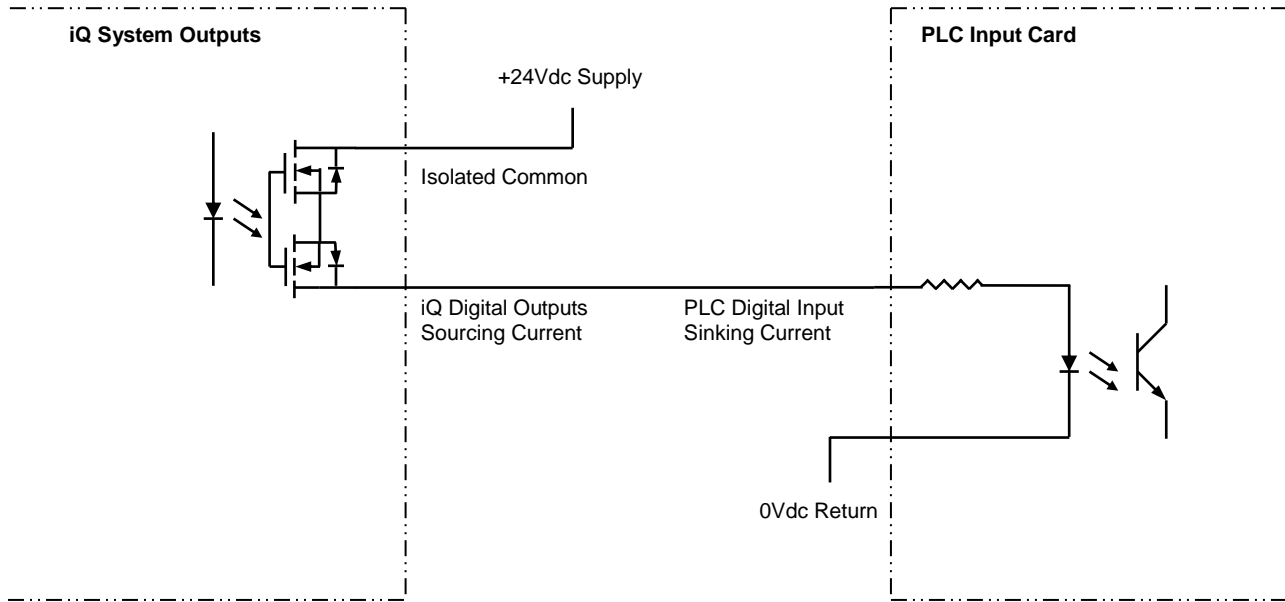



## Connecting an Automation Safety Circuit

**WARNING:** Consult the appropriate local regulatory agency (OSHA, UL, CE, etc.) regarding all of the safety requirements for your automated machine. Dukane is not responsible for injuries related to improper safety circuits or safety guarding used in an automated machine. EN 12100-1/-2 and EN 60204-1 safety standards are recommended.

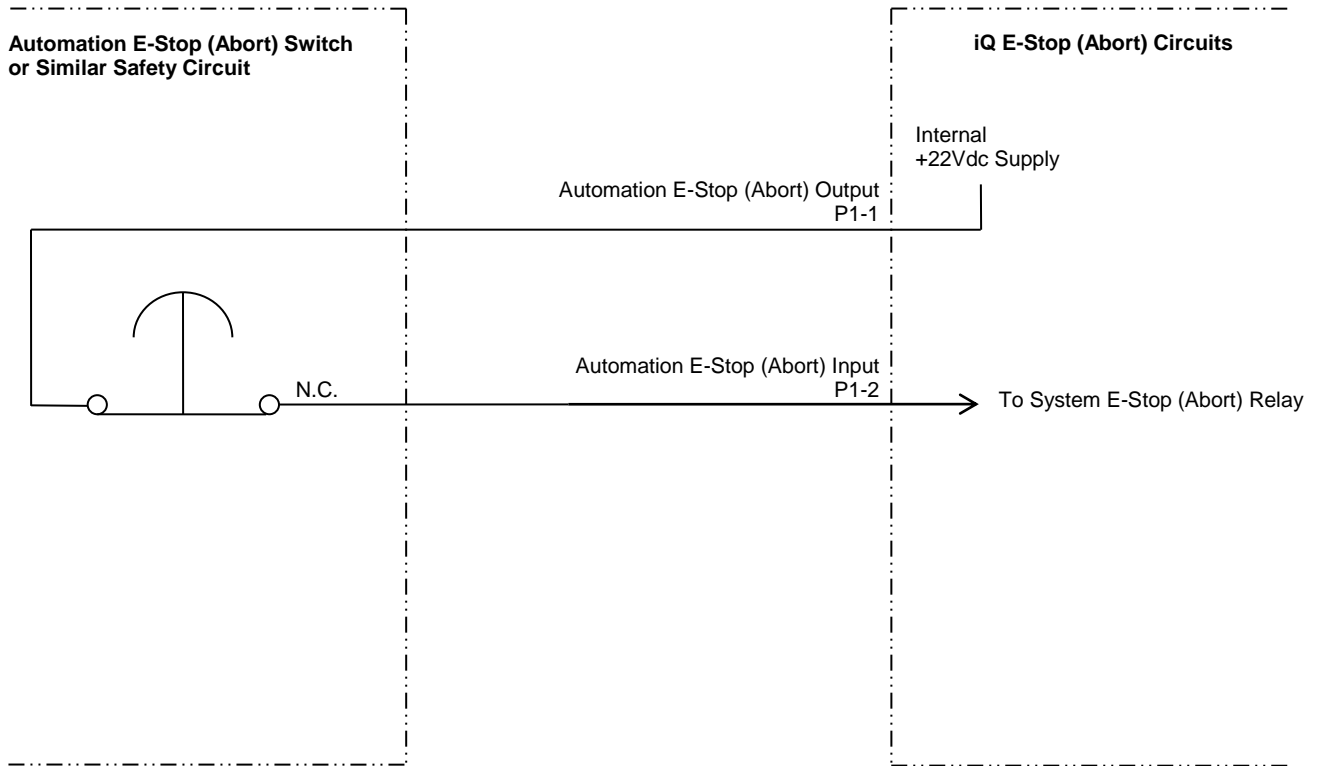

### Notes:

1. To operate the iQ Auto Plus Generator, P1 pins 1 and 2 must be maintained in a closed connection.
2. If the connection between P1 pins 1 and 2 is opened, the ultrasonic output will be disabled.

### Remote Setup Switching

Bit 3	Bit 2	Bit 1	Bit 0	Setup Selected
0	0	0	0	1
0	0	0	1	2
0	0	1	0	3
0	0	1	1	4
0	1	0	0	5
0	1	0	1	6
0	1	1	0	7
0	1	1	1	8
1	0	0	0	9
1	0	0	1	10
1	0	1	0	11
1	0	1	1	12
1	1	0	0	13
1	1	0	1	14
1	1	1	0	15
1	1	1	1	16

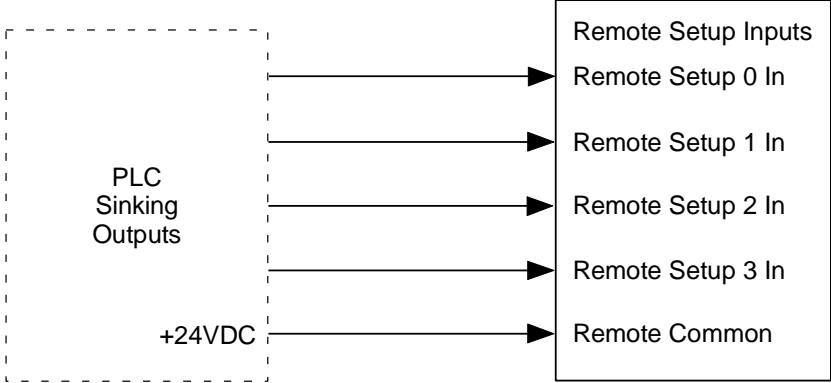
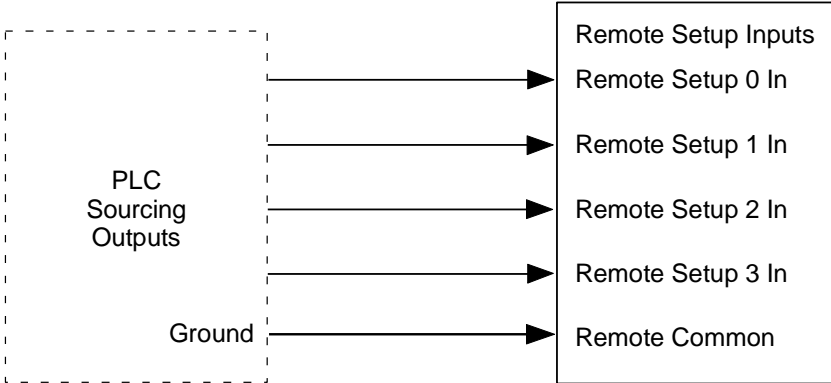

## iQ Auto Plus Timing

### iQ Auto Plus Weld-by-Automation

**Normal Weld Cycle** - A normal weld cycle lasts as long as the U/S Activate input is high. This cycle shows the timing between activation/deactivation of the U/S Activate input, U/S Status output and Ready Status output signals.

**The Ready Status Output:** The Ready Status output is used to determine if the generator is ready to start a new weld cycle. As seen in Figure 1 a minimum of 4.8ms is required for the Ready Status output to change state after the U/S Activate input is activated or deactivated. For correct operation, a PLC controlling a iQ Auto Plus generator must delay at least 4.8ms after activating or deactivating the U/S Activate input before checking the Ready Status output. After Ultrasound is turned off the stack will continue to vibrate (“Ring Down”) for some time that is stack and application dependent. The Ready Status output will not become active until this Ring Down completes. It is possible that this will make the delay between deactivating the U/S Status input and activation of the Ready Status output much longer.

**The U/S Status Output:** The U/S Status output is used to determine when the generator has activated its ultrasound output to the ultrasonic stack. As seen in Figure 1, the U/S Status output requires a minimum of 6.6ms to change to its activated state. For correct operation, a PLC controlling a iQ Auto Plus Automation generator must delay at least 6.6ms after activating the U/S Activate input before checking the U/S Status output. At the end of a normal cycle, the U/S Status output requires a minimum of 6.6ms to change to its deactivated state after the U/S Activate input has deactivated. For correct operation, a PLC controlling a iQ Auto Plus Automation generator must delay at least 6.6ms after deactivating the U/S Activate input before checking the U/S Status output.

**Weld Cycle with an Overload** - This weld cycle shows the same timing relationship as a normal weld cycle except the ultrasound output, indicated by the U/S Status output, is terminated early due to an overload condition.

**The Any Fault Status Output:** The Any Fault Status output is used to determine when the generator has terminated the weld cycle due to an overload. When an overload occurs, the Any Fault Status and Overload Status outputs activate at the same time the U/S Status output deactivates. The Ready Status output doesn't activate until the U/S Activate output deactivates. The Ready Status output requires a minimum of 4.8ms to change to its activated state after the U/S Activate input has deactivated. For correct operation, a PLC controlling a iQ Auto Plus generator must delay at least 4.8ms after deactivating the U/S Activate input before checking the Ready Status output. The Any Fault Status and Overload Status outputs will deactivate the next time the U/S Activate input is activated, but are delayed up to 4.3ms.

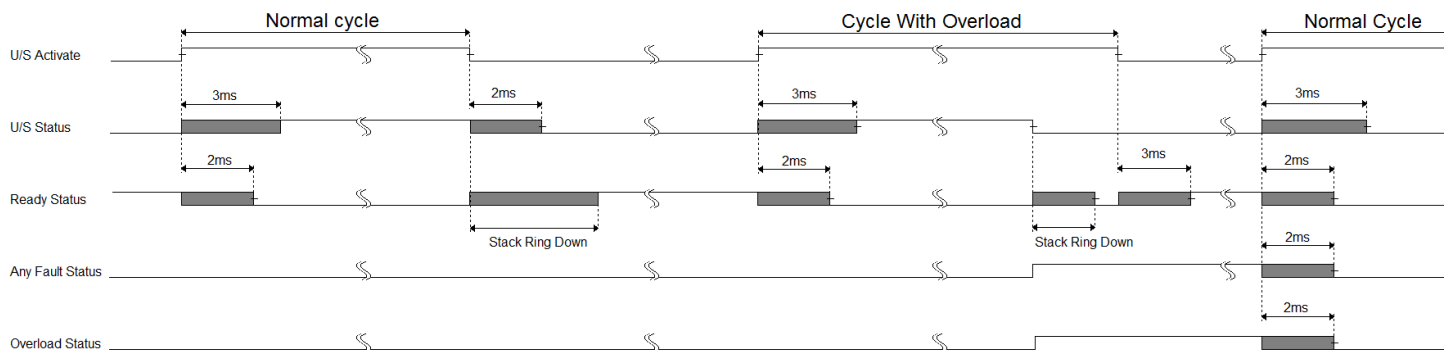

Figure 1: iQ Auto Plus Weld cycle (Weld-by-Automation)

## iQ Auto Plus Weld-by-Time

**Normal weld cycle:** This is a Weld-by-Time cycle, meaning the Ultrasound output lasts as long as the Time Setting which is 200ms in this case. An Auto Plus generator requires communications interface such as Ethernet/IP to configure the weld by Time, Peak Power, and Energy settings. While it is strongly recommended that the communications network be used instead of the discrete I/O, the network and discrete I/O can be used together. Figure 3 shows the timing for weld cycles that were configured via the network interface, but ultrasound is activated using the US Activate input instead of the network. As with Weld-by Automation the Ready Status output should be used to determine if the generator is ready to start a new weld cycle. As seen in Figure 3 a minimum of 4.8ms is required for the Ready Status output to change state after the activation of the U/S Activate input. The stack ring down time, which is stack and application dependent, may make this time much longer. For correct operation a PLC controlling an iQ Auto Plus must delay at least 4.8ms after activating the U/S Activate input before checking the Ready Status output. Since U/S Status takes up to 6.6ms to change state, a 6.6ms minimum delay is required when monitoring this output. If a network is connected to the generator then the US Activation can be controlled by the network. The same is true for monitoring the status outputs. The delays will vary with the network based on network settings, number of devices on the network, etc.

**Cycle With an Overload:** This weld cycle shows the same timing relationship except the ultrasound output, indicated by U/S Status, is terminated early, in this case after 100ms, due to an overload condition. The Any Fault Status and Overload Status outputs activate at the same time U/S Status deactivates. The Ready Status output activates after 4.8ms passes or ring down is complete whichever is first. The Any Fault Status and Overload Status outputs will deactivate the next time the U/S Activate input is activated, but are delayed up to 4.8 ms.

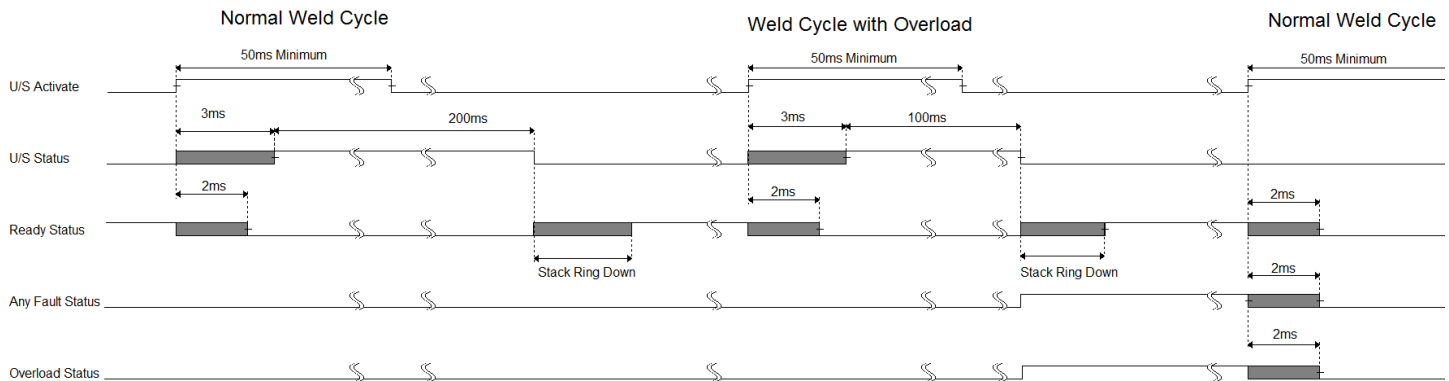

Figure 3: iQ Auto Plus Weld cycle (Weld-by-Time)

## iQ Auto Plus With MPCQ Weld-by-Automation Timing

**Probe selection changed between weld cycles:** Although the probe selection can be changed at any time this method is the safest and most predictable. The PLC program should monitor the Ready output and when it becomes active change the probe selection using the remote setup inputs. This will insure that the stack ring down from the previous cycle is finished. After a delay of at least 6ms the Ready output will change to inactive (low in this case) again and stay that way for 33ms. See Figure 2 where Remote Setup 0 changes from low to high. The PLC should continue to monitor the Ready output and start the next cycle when Ready changes to active (high in this case).

**Probe selection changed during a weld cycle:** Alternately the Remote Setup inputs can change during the weld cycle. The MPC circuitry will not select a new probe when the Ready output is not active. As can be seen in Figure 2 Remote Setup 0 input is changed to inactive before the weld cycle completes. Once the stack ring down completes the relays switch so that probe 1 is selected almost immediately, but the relay takes up to 2ms to settle. The Ready output will remain inactive for 33ms after ring down signal completes. In this case the PLC must monitor the Ready output and not activate the U/S Activate input until the Ready signal is active.

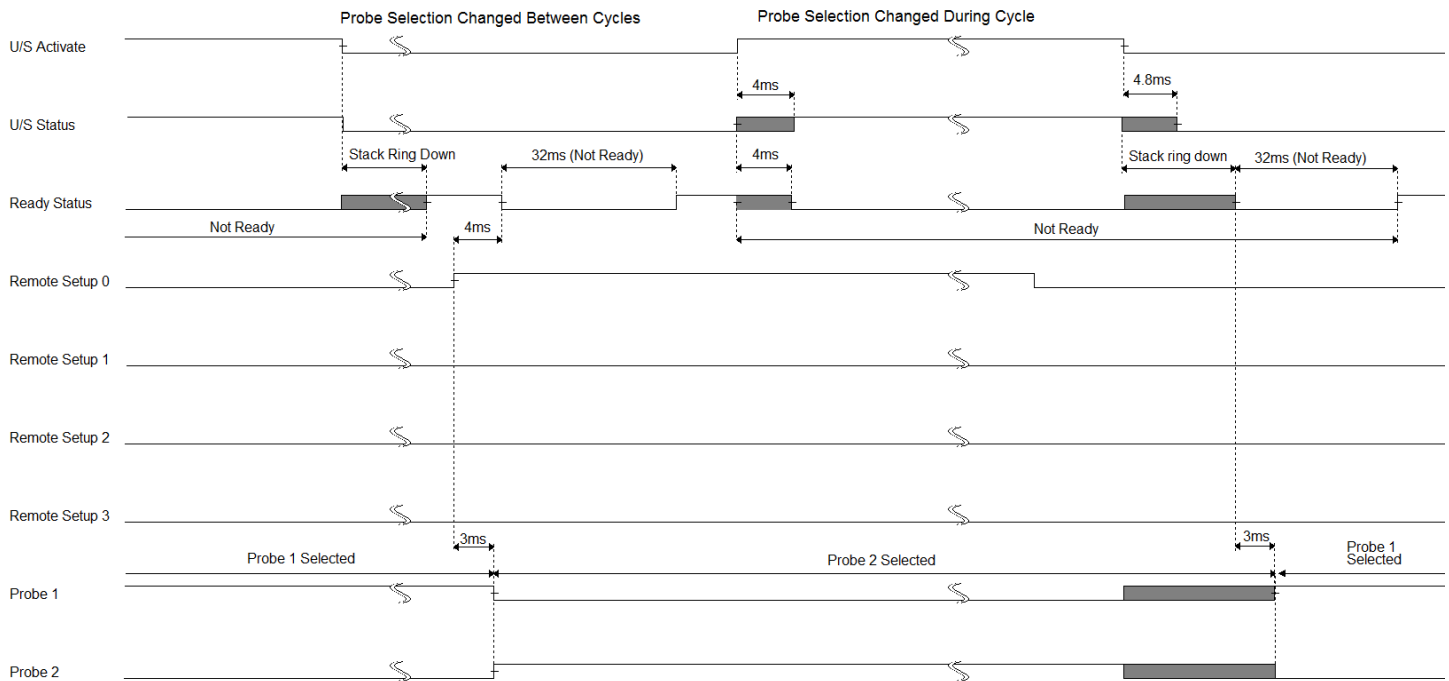

Figure 2 iQ Auto Plus with MPCQ Weld cycle (Weld-by-Automation)

Timing Diagram Notes: All Signals are active high and the grey areas indicate that the output could be either high or low. The  $\infty$  symbol indicates a time break so that the time where nothing is happening doesn't need to be shown.

**Dukane IAS, LLC**  
**Intelligent Assembly Solutions**

2900 Dukane Drive  
St. Charles, IL 60174 USA  
Tel: (630) 797-4900  
Fax: (630) 797-4949  
<http://www.dukane.com/us>

**Disclaimer:** Dukane IAS, LLC assumes no responsibility for any errors which may appear in this document, reserves the right to change devices or specifications detailed herein at any time without notice, and does not make any commitment to update the information contained herein.